

# PRODUCT SHEET

## Description:

Black Anodized Z-Profile, 3200mm, F/"Zapp" Door System

## Item number:

28.25.301-3

Units	Box	Carton	HS Code	Barcode
Pcs.	1	10	7604299090	

5704866509671

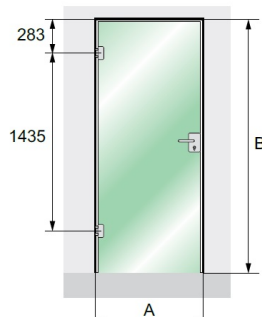
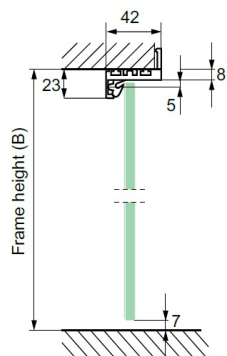
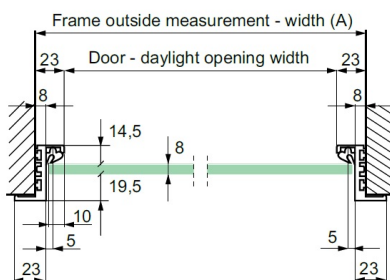
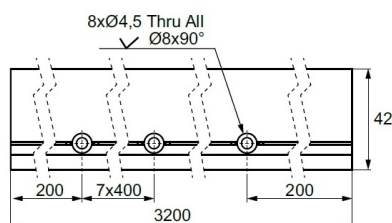
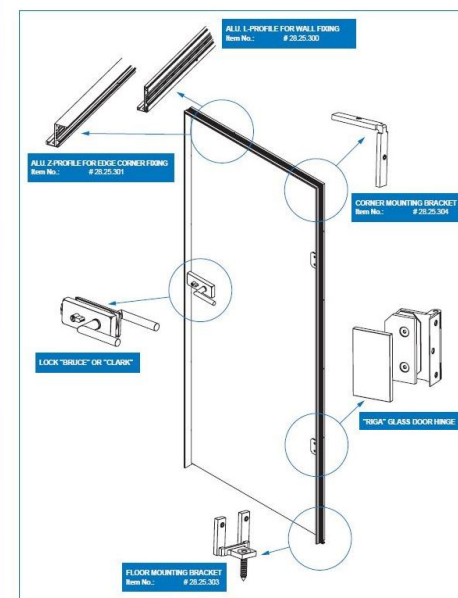
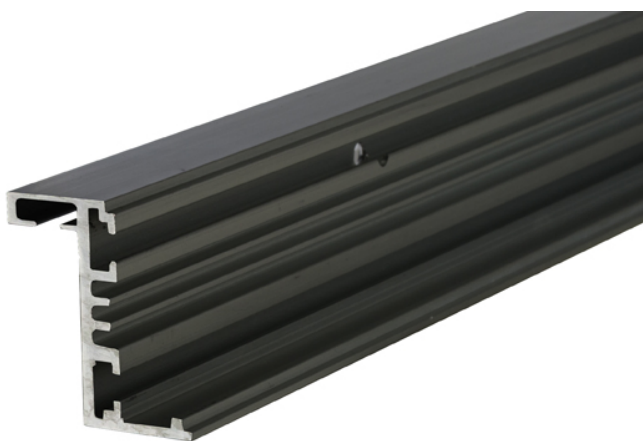

## SISO A/S

Mileparken 11  
DK-2740 Skovlunde  
Denmark  
VAT: DK 24786013

Phone +45 45 830 900

www.siso.dk  
siso@siso.dk

Danske Bank  
Nytorv Branch  
Copenhagen  
SWIFT: DABADKKK

Account no.  
4180 3112 112936  
IBAN Account  
DK7230003112112936